

Ritning på "Sennenvagnen"

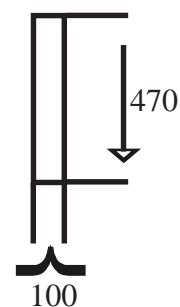
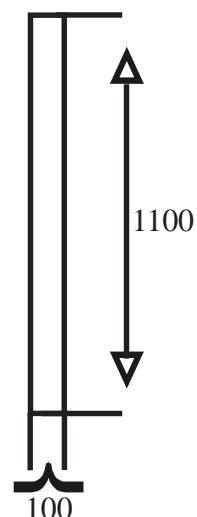
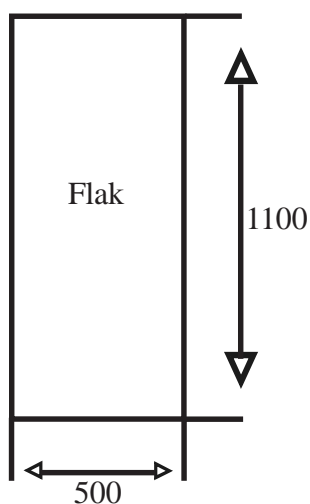
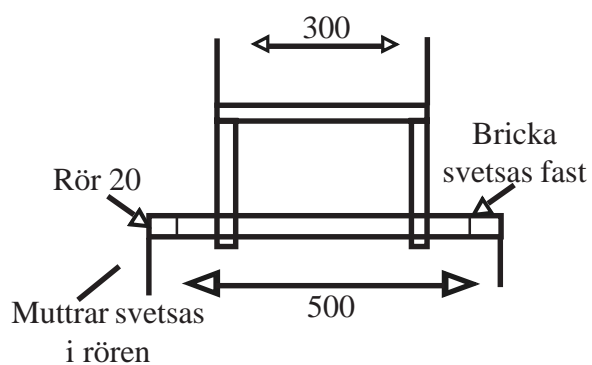
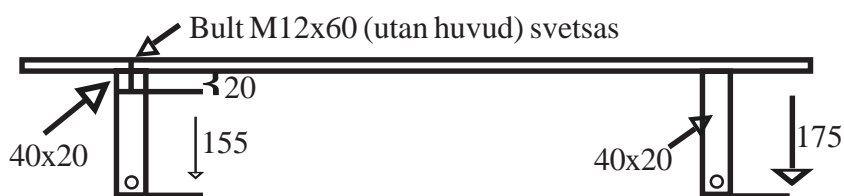
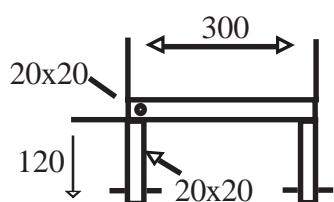
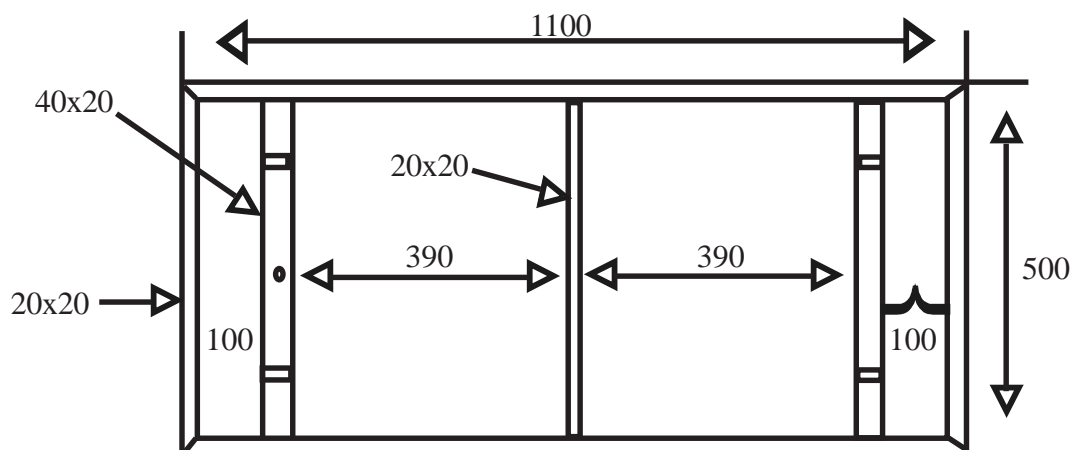

Fyrkantrör	20 x 20 mm	5 m	Karosseri bult		
Fyrkantrör	40 x 20 mm	2,5 m	+ mutter	M 6 x 70 mm	4 st
Axelrör	19,5–20 mm	1 m	Karosseri brickor	M 8 x 35 mm	4 st
Brickor	20 x 40 mm	8 st	Form plywood (flak)	10 mm	1 st
Bult	M8 x 25 mm	4 st	Luftgumihjul (Clas		
Bult med mutter	M12 x 60 mm	1 st	Ohlson, Insjön)	Nr 31–1280	4 st